

MARPLES

M44

PLOUGH

PLANE

(Working Instructions overleaf)



SHAMROCK



BRAND

MARPLES M44 PLOUGH PLANE is supplied with an adjustable depth gauge and fence, and a set of eight cutters, 1/8" to 9/16" wide by 1/16ths. For wider grooves two cuts can be made.

The fence can be used on either side of the body. The depth of the face can be increased by screwing on a wood fillet.

An additional pair of short fence arms is supplied for working in confined spaces.

Equipped with this handy Plane, a large variety of work can be undertaken with confidence, which hitherto has been beyond your scope.

Grooves and rebates up to 5/8" deep can be cut at distances up to 5" from the edge of the board.

The diagrams opposite illustrate a few of the many jobs waiting for your M44 Plane.

INSTRUCTIONS

Adjust the cutter for depth, and tighten the cap screw; then screw up the cutter-clamping screw as an additional precaution, to prevent any lateral movement.

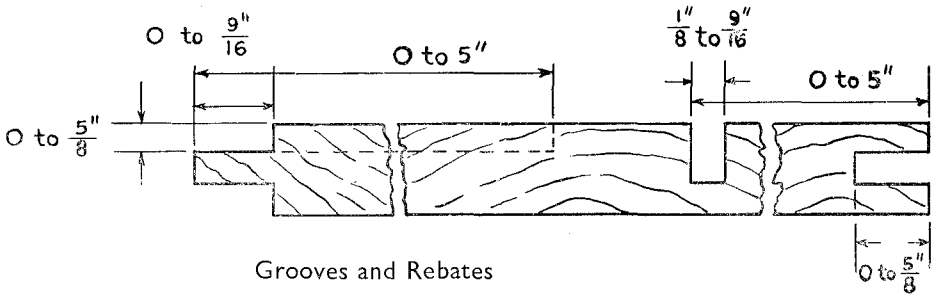

Grooves and Rebates

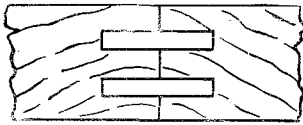

Glued edge and corner joints

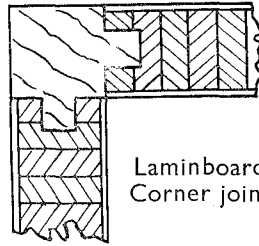
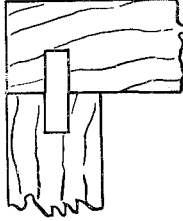
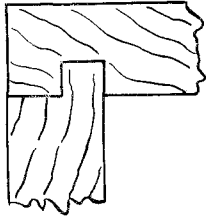
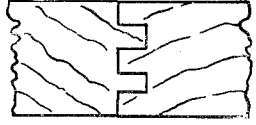

Laminboard Corner joint

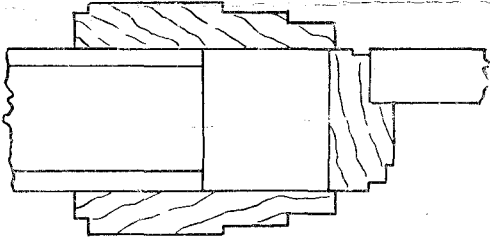

Architraves and Rebated Door Jamb.

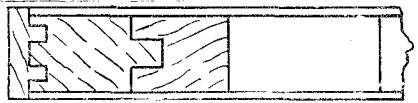

Flush Door Construction

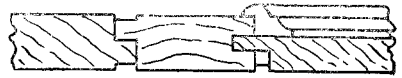

Door Closing Joint

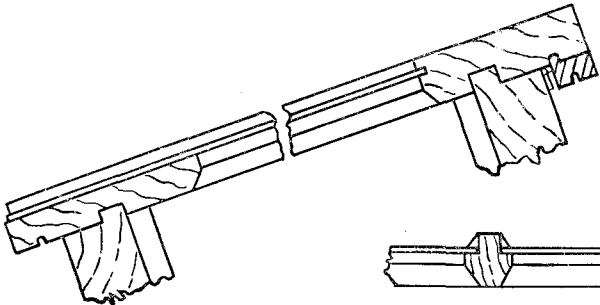

Skylight Construction

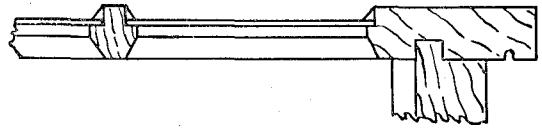



WILLIAM MARPLES & SONS LTD.,
Sheffield, England.

have been manufacturing their celebrated
SHAMROCK BRAND TOOLS
for over a hundred years

The ever-increasing demand for these fine tools has been a constant encouragement to the makers to increase production and to extend their range, which includes:—

- CHISELS - PLANE IRONS
- SCREWDRIVERS - TRY SQUARES
- CARPENTERS' GAUGES
- SPIRIT LEVELS
- WOOD AND METAL PLANES
- VICES - CRAMPS

&c., &c.

If YOU want a first-class Woodworking Tool,
ask for a

Marples "Shamrock Brand"

and SEE THAT YOU GET IT.